

CANDIDATE
NAME

CENTRE
NUMBER

--	--	--	--	--

CANDIDATE
NUMBER

--	--	--	--

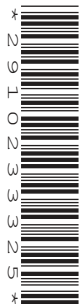

COMBINED SCIENCE

0653/63

Paper 6 Alternative to Practical

October/November 2016

1 hour

Candidates answer on the Question Paper.

No Additional Materials are required.

READ THESE INSTRUCTIONS FIRST

Write your Centre number, candidate number and name on all the work you hand in.

Write in dark blue or black pen.

You may use an HB pencil for any diagrams or graphs.

Do not use staples, paper clips, glue or correction fluid.

DO NOT WRITE IN ANY BARCODES.

Answer **all** questions.

Electronic calculators may be used.

You may lose marks if you do not show your working or if you do not use appropriate units.

At the end of the examination, fasten all your work securely together.

The number of marks is given in brackets [] at the end of each question or part question.

This document consists of **19** printed pages and **1** blank page.

- 1 A student investigates the nutrient content of soft cheese and tomatoes. He has access to three testing solutions.

Benedict's solution
 biuret solution
 iodine solution

He adds a small amount of distilled water to some soft cheese and stirs it with a stirring rod so that it loosens and can be poured.

He pours the cheese into each of three test-tubes and tests them for the nutrients shown in Table 1.1.

- (a) Complete Table 1.1 to show which solution he uses for each test and whether or not he needs to use heat for the test.

Table 1.1

nutrient tested for	testing solution	is heat required? (yes/no)
protein		
reducing sugar		
starch		

[3]

- (b) He obtains a positive result with the protein test only.

Complete Table 1.2 to show his observations.

Table 1.2

testing solution used	initial colour	colour after test
Benedict's	blue	
biuret	blue	
iodine	brown	

[2]

- 2 A student investigates how the concentration of hydrochloric acid affects the speed of reaction between calcium carbonate and hydrochloric acid.

She is provided with marble chips (calcium carbonate) and solutions of hydrochloric acid of concentration, 1.00Q, 0.75Q and 0.50Q, where Q is a unit of concentration.

- (a)
- She places limewater in a test-tube.
 - She places a delivery tube in the limewater.
 - She places hydrochloric acid of concentration 1.00Q in another test-tube.
 - She adds ten marble chips to the acid in the test-tube and starts a stopclock.
 - She quickly attaches the bung of the delivery tube so that the gas produced passes into the limewater as shown in Fig. 2.1.

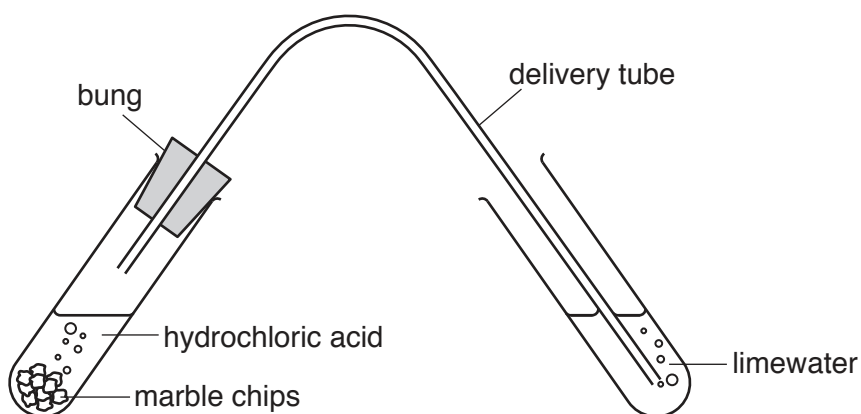
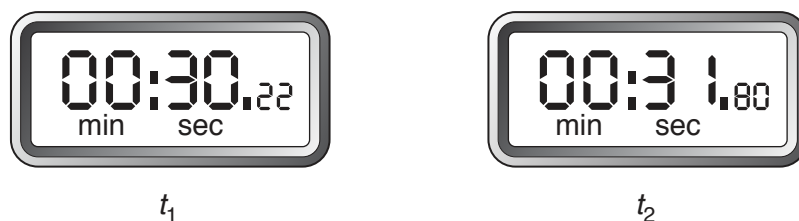

Fig. 2.1

- She stops the stopclock at the first appearance of a white precipitate in the limewater.
- She records in Table 2.1 this time t_1 to the nearest second for concentration 1.00Q.
- She repeats the procedure above and records in Table 2.1 the time t_2 to the nearest second for concentration 1.00Q.

The stopclock readings of t_1 and t_2 for concentration 1.00Q are shown in Fig. 2.2. Read the stopclocks to the nearest second and record the values in Table 2.1 on page 6. [2]



readings for hydrochloric acid of concentration 1.00Q

Fig. 2.2

Table 2.1

concentration of hydrochloric acid/Q	time t_1 for white ppt. to appear/s	time t_2 for white ppt. to appear/s	average time t_a for white ppt. to appear/s	speed of reaction, $\frac{1}{t_a}$
1.00				
0.75	49	57	53	
0.50	82	86	84	

- (b) She repeats the procedure in (a), firstly using hydrochloric acid of concentration 0.75 Q and then using concentration 0.50 Q.

The results of these experiments are shown in Table 2.1.

- (i) Calculate the average time t_a for the concentration of 1.00 Q and record the value in Table 2.1.

[1]

- (ii) For each concentration of hydrochloric acid calculate $\frac{1}{t_a}$.
 $\frac{1}{t_a}$ is a measure of the speed of reaction.

Record in Table 2.1 the values **to three decimal places**.

[1]

- (c) (i) On the grid provided, plot a graph of the speed of reaction against the concentration of hydrochloric acid used.

Draw the most appropriate straight line or curve **through the origin**.

[3]

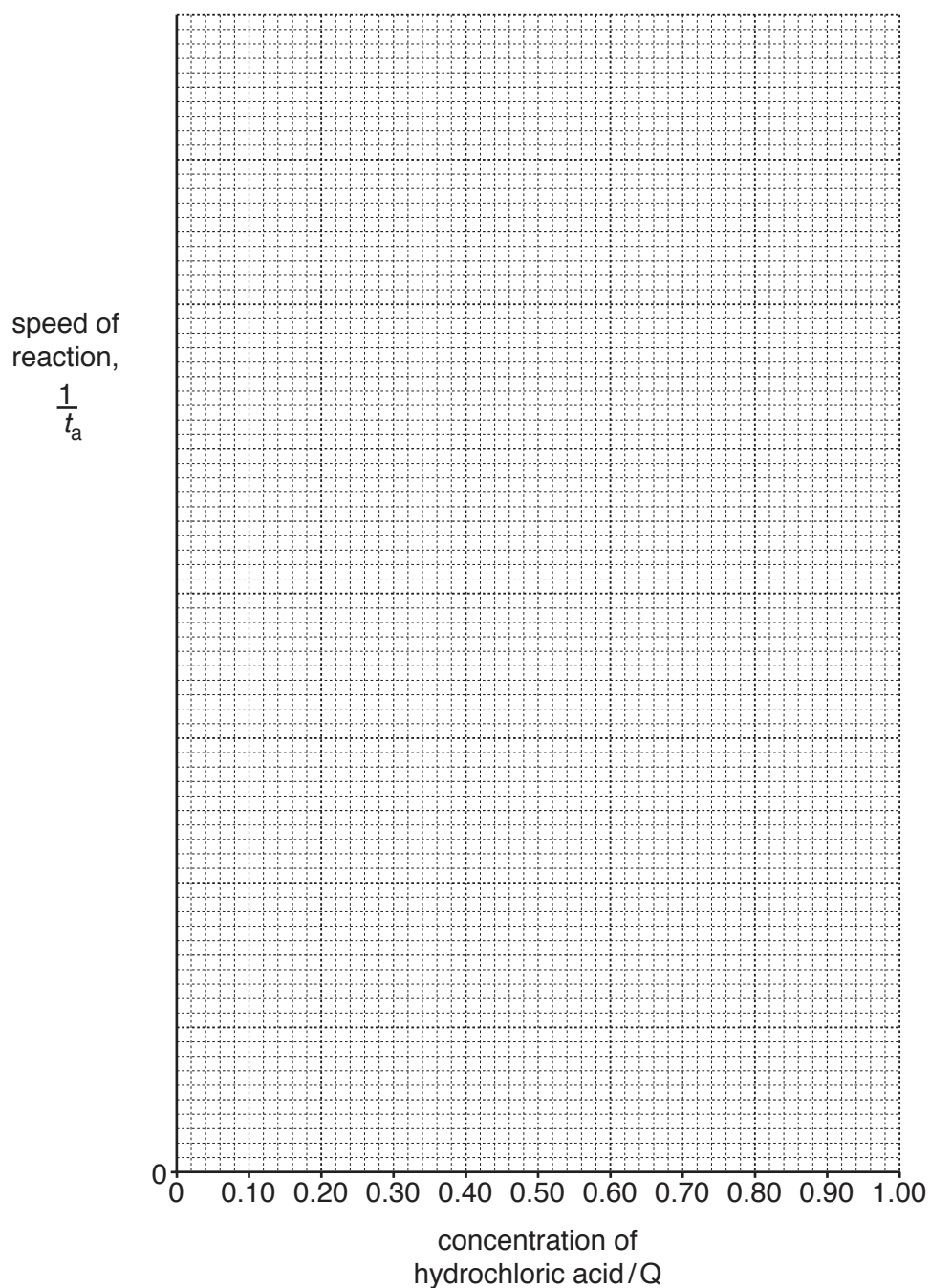

- (ii) Using your graph state the relationship between the speed of the reaction and the concentration of hydrochloric acid.

.....
.....[1]

- (d) The student considers the results in Table 2.1. She is unhappy about the results for one of the concentrations of hydrochloric acid.

Suggest which concentration and state why the times are less satisfactory than the other results.

concentration

reason

.....

[1]

- (e) Explain why it is important to replace the marble chips for each different experiment.

.....

.....[1]

- 3 A student investigates the total resistance of different combinations of identical resistors. She sets up the circuit shown in Fig. 3.1.

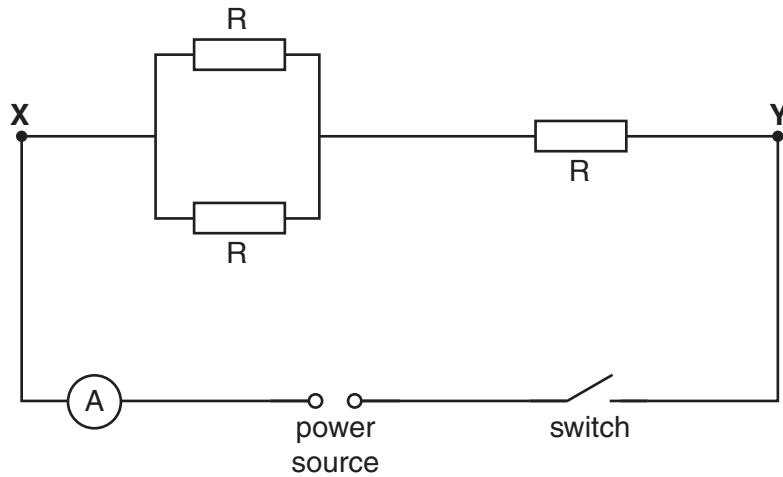

Fig. 3.1

- (a) She switches on the circuit by closing the switch and measures the potential difference V between **X** and **Y** and then switches off by opening the switch.
- (i) Complete Fig. 3.1, to show how the voltmeter is connected to measure the potential difference V . [2]
- (ii) Fig. 3.2 shows the voltmeter reading.

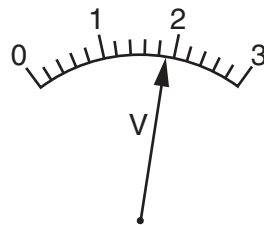

Fig. 3.2

Record the voltmeter reading V .

$V = \dots\dots\dots V$ [1]

- (iii) The student closes the switch, records the current I shown on the ammeter and then opens the switch. Fig. 3.3 shows the ammeter reading.

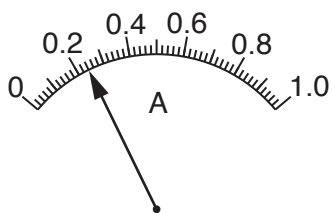

Fig. 3.3

Record the ammeter reading I .

$I = \dots\dots\dots$ A [1]

- (iv) Calculate the total resistance R_T of the combination of the three resistors in Fig. 3.1 using the equation:

$$R_T = \frac{V}{I}$$

Include the unit of resistance in your answer.

$R_T = \dots\dots\dots$ unit = $\dots\dots\dots$ [2]

- (b) The student disconnects the resistors from the circuit and reconnects the resistors in the circuit so that all three resistors are in series between points **X** and **Y** as shown in Fig. 3.4.

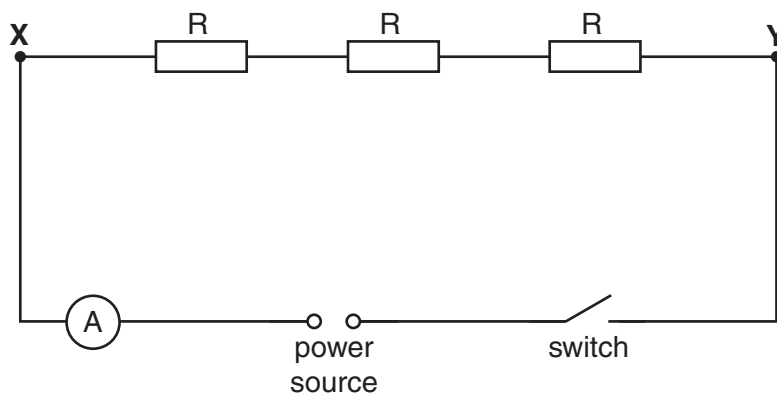

Fig. 3.4

She closes the switch and measures the potential difference V_S between **X** and **Y** and the current I_S . Her readings are shown in Table 3.1 on page 11.

Table 3.1

potential difference V_S/V	current I_S/A
1.8	0.12

Calculate the total resistance R_S of the series combination of the three resistors using the equation:

$$R_S = \frac{V_S}{I_S}$$

$$R_S = \dots\dots\dots [1]$$

(c) Theory suggests that because the resistors are identical:

$$R_T = 0.5 R_S$$

State whether the student's results support the theory and justify your statement by reference to the results.

statement

justification

..... [1]

(d) Explain why it is important to switch the circuit off between taking readings.

.....

..... [1]

(e) Predict **how** the reading on the ammeter **changes** if the three resistors in Fig. 3.4 are replaced by just one of the resistors connected between **X** and **Y**. Assume that the potential difference between **X** and **Y** stays the same.

.....

..... [1]

4 A student investigates gas exchange in animals and plants.

She uses a bicarbonate indicator to detect changes in the concentration of carbon dioxide. The chart in Fig. 4.1 shows the colour of the indicator for different concentrations of carbon dioxide.

	concentration of carbon dioxide		
	low	medium	high
colour of bicarbonate indicator	purple	red	yellow

Fig. 4.1

- The student sets up four test-tubes as shown in Fig. 4.2.

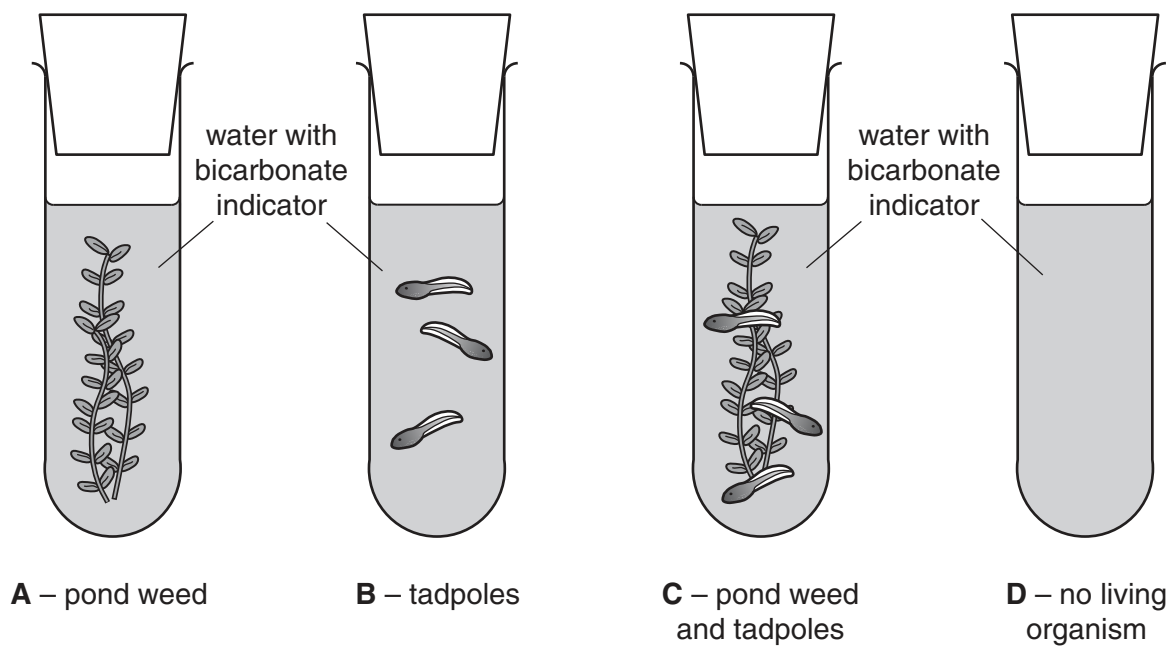

Fig. 4.2

- She places the test-tubes in the light.
- She returns 2 hours later and records her observations in Table 4.1.

Table 4.1

test-tube	initial colour	final colour	change in carbon dioxide concentration (increase / decrease / no change)
A	red	purple	
B	red	yellow	
C	red	red	no change
D	red	red	

(a) Fill in the last column of Table 4.1 to show what happened to the carbon dioxide concentrations after 2 hours. [1]

(b) (i) Explain why the concentration of carbon dioxide changes in test-tube **A**.

.....
.....[1]

(ii) Explain why the concentration of carbon dioxide changes in test-tube **B**.

.....
.....[1]

(iii) Suggest why the concentration of carbon dioxide remains the same in test-tube **C**.

.....
.....[1]

(c) Explain the purpose of test-tube **D**.

.....
.....[1]

(d) (i) The student keeps the four test-tubes at the same temperature.

State how this can be done and suggest a suitable temperature.

method
temperature [2]

(ii) Suggest **three** other factors that the student needs to keep constant when setting up this experiment.

1
2
3 [3]

5 The science class are investigating the properties of three oxides **J**, **K** and **L**.

J is a solid, **K** is a liquid and **L** is a gas. Fig. 5.1 shows the apparatus.

The teacher has not told the students the names of the oxides.

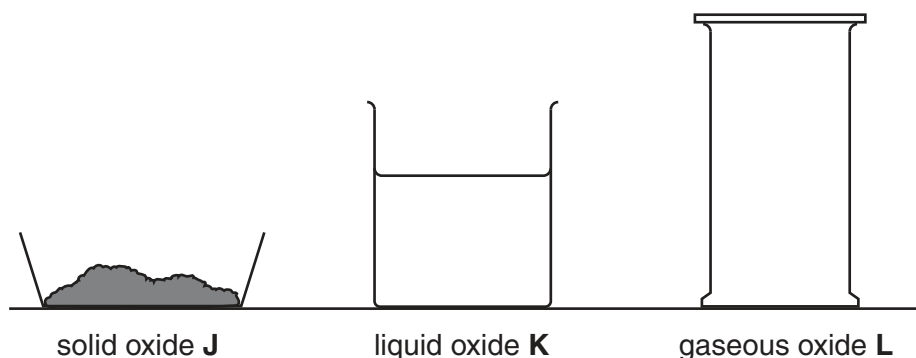
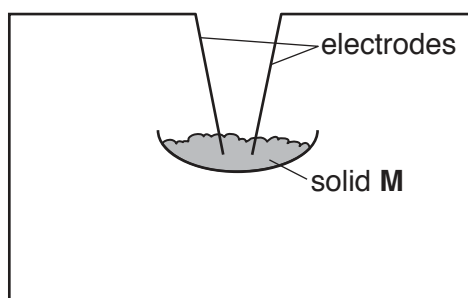

Fig. 5.1

(a) A student experiments with these three oxides. Oxide **J** is a black solid.

- He thinks that oxide **J** contains oxygen combined with a metal.
- He mixes the oxide with powdered charcoal and strongly heats the mixture in a crucible.
- The oxide turns from black to a brown-pink coloured solid **M**.
- The student is testing the brown-pink solid to see if it will conduct electricity.
- He has started to draw a circuit diagram as shown in Fig. 5.2.

(i) Complete Fig. 5.2 by adding **two** electrical (circuit) symbols for components that will allow the student to show that solid **M** conducts electricity.



[2]

Fig. 5.2

(ii) State the name of solid oxide **J**.

name

(b) A student sets up apparatus to measure the boiling point of oxide **K**.

When heated, oxide **K** boils. The student wants the vapour to pass into the condenser.

Fig. 5.3 shows part of the apparatus he sets up.

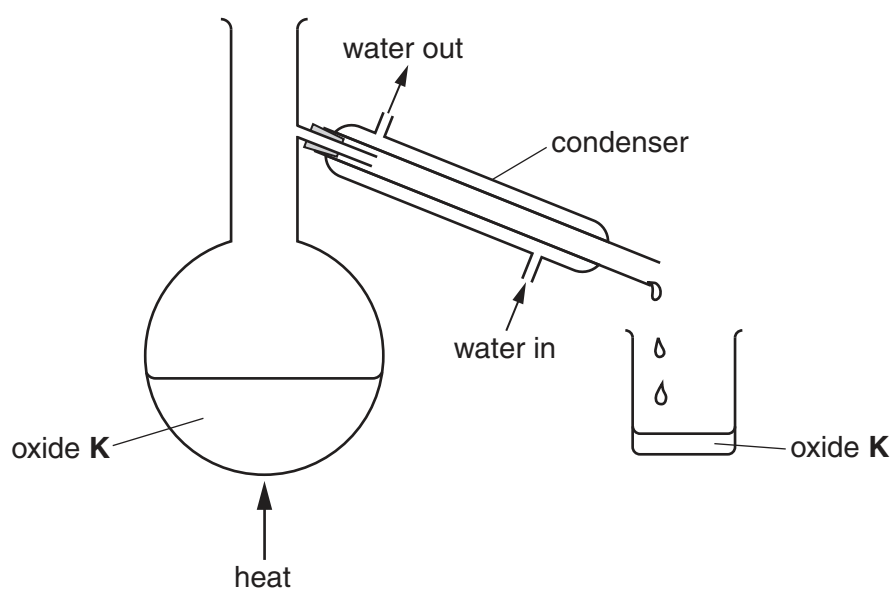

Fig. 5.3

- (i) Complete Fig. 5.3 including a thermometer. Draw the bulb of the thermometer in the correct place so that the accurate boiling point of the liquid will be shown on the scale. [2]

(ii) Fig. 5.4 shows the thermometer scale when oxide **K** is boiling.

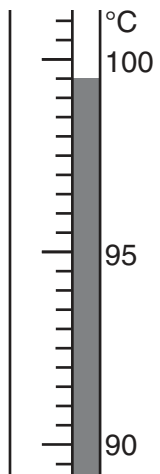

Fig. 5.4

Read the scale and record the boiling point of the oxide **K**.

boiling point =°C [1]

(iii) The student concludes that oxide **K** is water. Another student says that it cannot be water because water boils at 100°C.

Suggest how the student can justify his conclusion that the oxide **K** is water.

.....
[1]

(c) A student adds some limewater to a gas-jar of oxide **L** and replaces the lid. He shakes the gas-jar and the limewater turns milky.

State the name of oxide **L**.

name [1]

(d) The procedure used in (a) does not work for all metal oxides. An alternative procedure is to react the solid oxide with nitric acid to produce metal ions in solution.

State how a student can identify the metal ion in the solution produced from solid **M**. In your answer include the testing reagent and how the metal ion may be identified from the observations.

.....

[2]

Please turn over for Question 6.

6 A student is given three liquids labelled **R**, **S** and **T**.

The student has a mass balance, a 50 cm³ measuring cylinder and samples of the three liquids.

- She places the measuring cylinder on the balance and weighs it. She records the mass in Table 6.1.
- She adds liquid **R** to the measuring cylinder until the total mass is approximately 60g. She records the actual mass in Table 6.1.
- She measures the volume of liquid **R**.
- She repeats the procedure using samples of the other two liquids with the same measuring cylinder.

(a) (i) Fig. 6.1 shows the measuring cylinders for liquids **R** and **S**.

Read the volumes to the nearest 0.5 cm³ and record the values in Table 6.1.

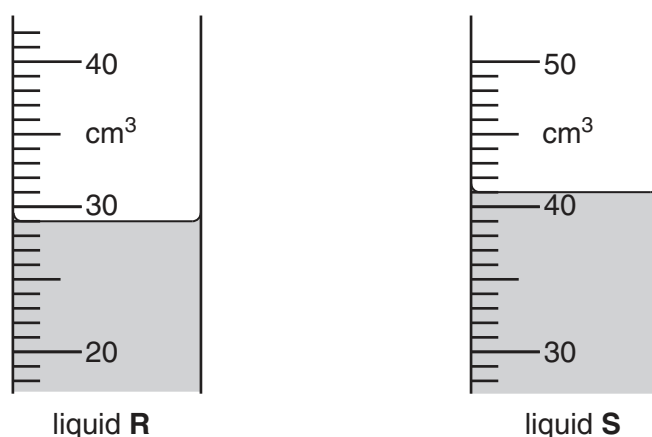

[2]

Fig. 6.1

Table 6.1

	liquid		
	R	S	T
mass of measuring cylinder + liquid/g	60.1	59.9	60.0
mass of measuring cylinder/g	25.5	25.5	25.5
mass of liquid/g	34.6	34.4	34.5
volume of liquid in measuring cylinder/cm ³			34.5
density of liquid / g per cm ³			1.0

- (ii) Explain how the student makes sure that her readings from the measuring cylinder are as accurate as possible. You may draw a diagram to help your explanation.

.....
[1]

- (b) Use the data in Table 6.1 and the formula below to calculate the densities of liquids **R** and **S**.

Record the densities in Table 6.1 to **one decimal place**.

$$\text{density} = \frac{\text{mass}}{\text{volume}}$$

[2]

- (c) (i) Name a piece of apparatus that the student could use to add the last few drops of liquid to the measuring cylinder so that the total mass is close to 60g.

.....[1]

- (ii) Suggest a reason why the student does not need to make the total mass exactly 60.0g to calculate density.

.....
[1]

- (iii) The student knows that her results for the densities of the liquids will be slightly inaccurate.

She repeats the experiment two more times, giving three results for the volumes and masses of each liquid.

Suggest how she can use the results of the three experiments to find more reliable values for the densities of the liquids.

.....
[1]

- (d) (i) Liquid **T** is water. Hydrocarbon oils float on water.

State which of the liquids, **R** or **S**, is a hydrocarbon oil and give a reason for your answer.

liquid because

.....[1]

- (ii) The third liquid is an aqueous solution of a salt.

The student pours 10cm^3 of each of the liquids **R**, **S** and **T** into one new measuring cylinder. She stirs the mixture and allows it to settle.

Complete Fig. 6.2 to show what she would observe when the mixture has settled. Label your diagram.

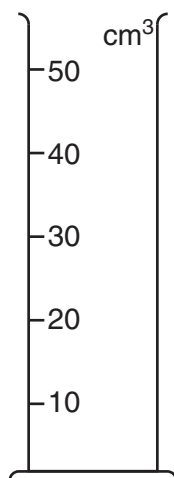

[1]

Fig. 6.2

Permission to reproduce items where third-party owned material protected by copyright is included has been sought and cleared where possible. Every reasonable effort has been made by the publisher (UCLES) to trace copyright holders, but if any items requiring clearance have unwittingly been included, the publisher will be pleased to make amends at the earliest possible opportunity.

To avoid the issue of disclosure of answer-related information to candidates, all copyright acknowledgements are reproduced online in the Cambridge International Examinations Copyright Acknowledgements Booklet. This is produced for each series of examinations and is freely available to download at www.cie.org.uk after the live examination series.

Cambridge International Examinations is part of the Cambridge Assessment Group. Cambridge Assessment is the brand name of University of Cambridge Local Examinations Syndicate (UCLES), which is itself a department of the University of Cambridge.